

Total solder points: 82

Difficulty level: *beginner* 1 2 3 4 5 *advanced*

2 MODULAR DIGITS WITH SERIAL INTERFACE



K8063

Multiple units can be linked in an easy way to create larger readouts for e.g. Score-keeping, timing, counting, ...

The K8063 is a 7-segment display which can be controlled by a two-wire serial connection, using the RS232 protocol. The protocol is platform-independent i.e. any computer running any programming language can control the K8063, as long as it is equipped with a serial port. Up to 255 units can be individually addressed, allowing you to create large display systems for e.g. scoreboards, clocks, timers, thermometers, games, ...

Features

- Red bright 57mm jumbo 7-segment display
- Complete with snap-in enclosure
- Multiple units can easily be linked in order to create larger readouts for different purposes e.g. scorekeeping, timing, counting, ...
- Easy platform-independent control via three-wire RS232 interface
- Up to 255 separate units can be addressed
- Tested with distances of up to 50m between PC and display
- Use our optional PCUSB6 for USB connection

Specifications

- Power supply: 9 to 12Vdc / 120mA per display
- RS232 interface: 2400baud / 8databits / no parity / 1 stop bit
- Dimensions: 74 x 58.5 x 32mm

 The general manuals containing guidelines for assembly, safety and electromagnetic compatibility can be downloaded from our Velleman website ([support / manuals / HALG](#)).

1. Assembly (Skipping this can lead to troubles !)

Ok, so we have your attention. These hints will help you to make this project successful. Read them carefully.

1.1 Make sure you have the right tools:

- A good quality soldering iron (25-40W) with a small tip.
- Wipe it often on a wet sponge or cloth, to keep it clean; then apply solder to the tip, to give it a wet look. This is called 'thinning' and will protect the tip, and enables you to make good connections. When solder rolls off the tip, it needs cleaning.
- Thin rosin-core solder. Do not use any flux or grease.
- A diagonal cutter to trim excess wires. To avoid injury when cutting excess leads, hold the lead so they cannot fly towards the eyes.
- Needle nose pliers, for bending leads, or to hold components in place.
- Small blade and Phillips screwdrivers. A basic range is fine.

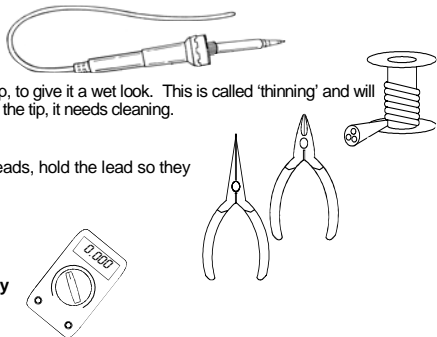

For some projects, a basic multi-meter is required, or might be handy

1.2 Assembly Hints :

- ⇒ Make sure the skill level matches your experience, to avoid disappointments.
 - ⇒ Follow the instructions carefully. Read and understand the entire step before you perform each operation.
 - ⇒ Perform the assembly in the correct order as stated in this manual
 - ⇒ Position all parts on the PCB (Printed Circuit Board) as shown on the drawings.
 - ⇒ Values on the circuit diagram are subject to changes.
 - ⇒ Values in this assembly guide are correct*
 - ⇒ Use the check-boxes to mark your progress.
 - ⇒ Please read the included information on safety and customer service
- * Typographical inaccuracies excluded. Always look for possible last minute manual updates, indicated as 'NOTE' on a separate leaflet.

1.3 Soldering Hints :

1- Mount the component against the PCB surface and carefully solder the leads

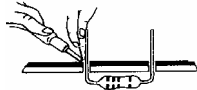

2- Make sure the solder joints are cone-shaped and shiny

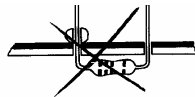
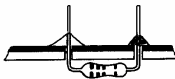

3- Trim excess leads as close as possible to the solder joint

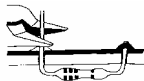

REMOVE THEM FROM THE TAPE ONE AT A TIME !

**AXIAL COMPONENTS ARE TAPED IN THE
CORRECT MOUNTING SEQUENCE !**

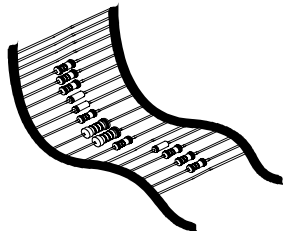

 You will find the colour code for the resistances and the LEDs in the HALG (general manual) and on our website: <http://www.velleman.be/common/service.aspx>

Remark: all components are supplied in a double quantity to allow the assembly of 2 digits. Repeat the procedure of the first digit to assemble the second one.

1. Zener diodes. Watch the polarity !

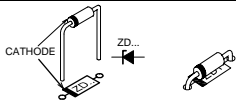

- ZD1 : 5V1
- ZD2 : 5V1
- ZD3 : 4V3

2. Diode. Watch the polarity !

- D1 : 1N4007

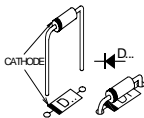

3. Resistors

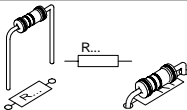

- R1 : 560 (5 - 6 - 1 - B)
- R2 : 560 (5 - 6 - 1 - B)

☞ **Mount R2 at end of chain !**

For example: when linking 4 digits, mount the resistor R2 on the last (4th) digit and leave its space open on the other 3 digits.

- R3 : 10K (1 - 0 - 3 - B)
- R4 : 1K (1 - 0 - 2 - B)
- R5 : 100 (1 - 0 - 1 - B)
- R6 : 100 (1 - 0 - 1 - B)
- R7 : 100 (1 - 0 - 1 - B)
- R8 : 100 (1 - 0 - 1 - B)
- R9 : 100 (1 - 0 - 1 - B)
- R10 : 100 (1 - 0 - 1 - B)

- R11 : 100 (1 - 0 - 1 - B)
- R12 : 100 (1 - 0 - 1 - B)
- R13 : 100K (1 - 0 - 4 - B)

4. IC socket. Watch the position of the notch!

- IC1 : 14p

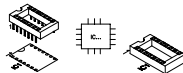

5. Capacitors

- C1 : 100nF (104)
- C2 : 100nF (104)
- C3 : 100nF (104)



6. Voltage regulator

- VR1 : UA7809

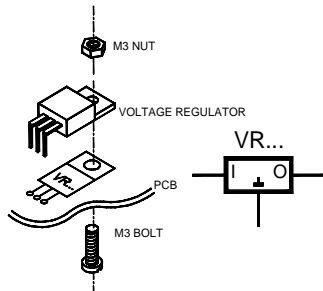

7. Transistor.

- T1 : BC547B

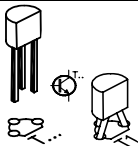

8. Electrolytic Capacitors. Watch the polarity !

- C4 : 100 μ F
□ C5 : 100 μ F

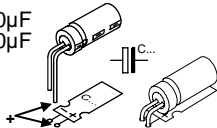

9. Pin header

- SK7 :
2p

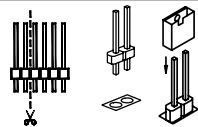

10. PCB tabs

- RS232 (2x)
□ + (2x)
□ GND (2x)

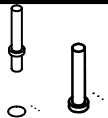

Remark: on the outer digits, only the PCB tabs close to the IC have to be mounted.

11. Tulip pin headers

- 10x

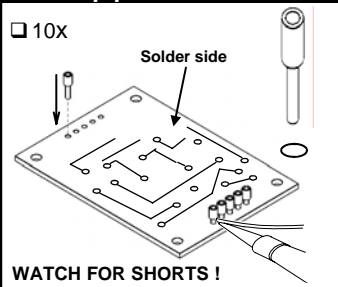

WATCH FOR SHORTS !

12. IC. Watch the position of the notch!

- IC1 : VK8063

Programmed PIC16F630

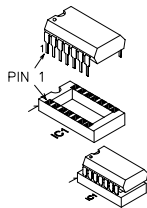

13. Assembly

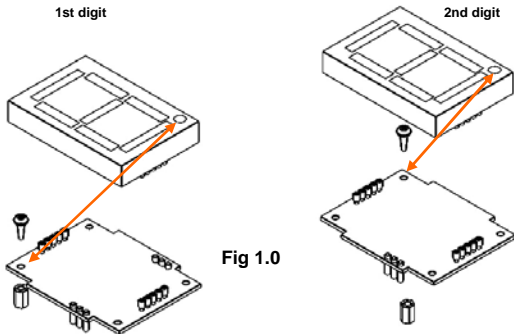

Fig 1.0

Mount the spacers onto the PCB with the 2 included screws and install the digit display on the solder side of the PCB. Pay attention to the position of the decimal point, see figure 1.0.

Then turn the PCB around and place it into the housing with the display towards the front, see figure 2.0.

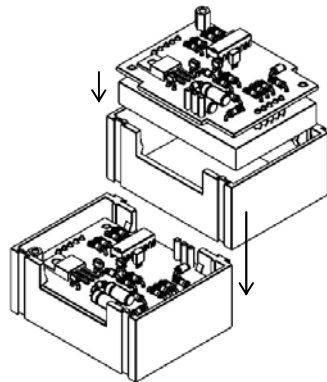

Fig 2.0

If you want to mount the digit(s) on the wall, finish by mounting the brackets on the PCB, see figure 3.0

Parker screw
2,9 x 12,7mm

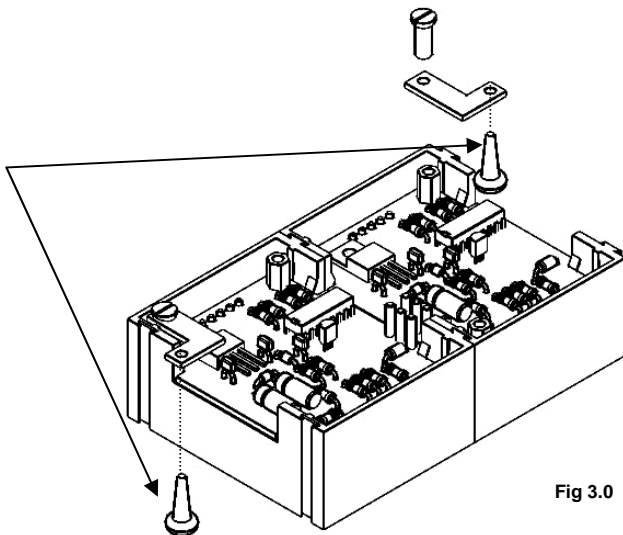

Fig 3.0

14. Test

When the assembly has been completed, we recommended to test each individual unit before daisy-chaining them. Make sure SK7 (address jumper) is put in place, see figure 4.0.

Connect a 9 to 12VDC power supply to the pins GND and +V.

At power-on, the K8063 will display .0123456789 (segment test).

Next, it will display its current address (default : 1) for a couple of seconds.

At this time, the K8063 allows you to select an address ranging from 0 to 19*. Simply wait until the desired address is displayed and remove the SK7 address jumper. (note : addresses 0 to 9 are displayed as 0 to 9, addresses 10 to 19 are displayed as 0. to 9. (note the dot).

The K8063 will loop the addresses until the jumper is removed, so if you have missed the desired address, you can wait a while and it will appear again.

Once you have removed the jumper, the K8063 stops looping and after a couple of seconds the display will turn blank. The selected address is now stored in its memory.

*If you require 20 or more different addresses, you can configure them when the K8063 units are hooked-up to the computer (see further in this manual).

Fig 4.0

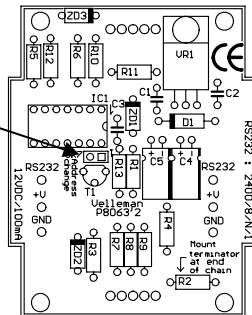

15. Hook-up

Hook-up : All units have two sets of connectors. This allows you to hook them up in an easy way, as shown below (fig. 5.0):

Female 9P SUBD connector

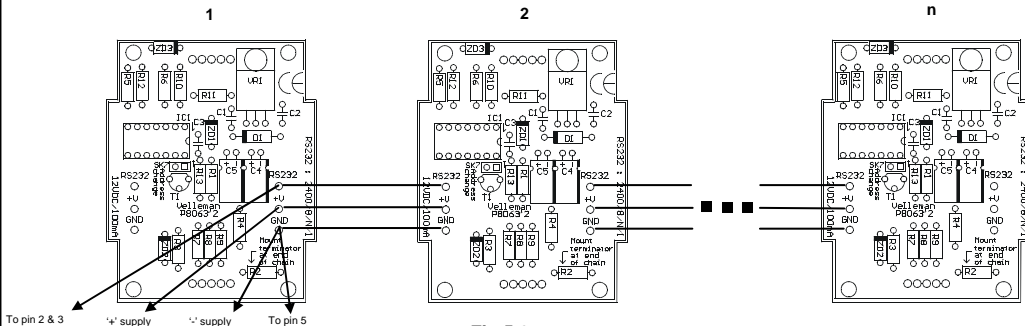
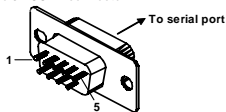

Fig 5.0

Power supply : The K8063 requires a 9 to 12VDC power supply. Power consumption is 120mA max. per unit (12V) (e.g. if you have 5 units, you need a power supply capable of delivering at least $5 \times 120 = 600\text{mA}$). Note : If the total # of displays exceeds 6, it is required to wire the units according to the drawing below, as the PCB tracks are unable to handle the large currents that flow when more than 6 units are operated simultaneously. Furthermore, if more than 15 units are operated at the same time, we recommend to use a separate power supply for every group of 15 digits, to avoid large currents and to avoid the need for heavy wiring. (Fig 6.0).

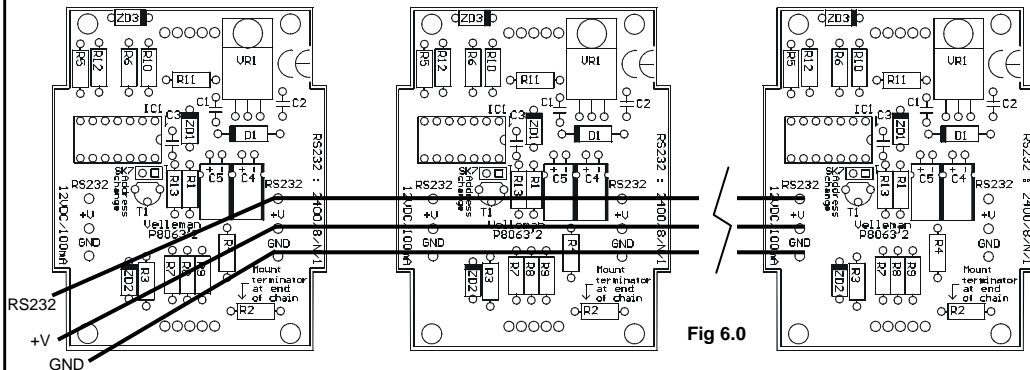

Fig 6.0

Serial port specifications : The K8063 can be hooked up to any serial port which supports the RS232 standard (e.g. PC COM port). Serial port settings are 2400/8/n/1 (2400 baud, 8 databits, no parity, 1 stopbit).

Serial port connection : Connect the pin marked 'RS232' to pins 2&3 of the 9P SUBD connector. Connect the pin marked 'GND' to pin 5 of the 9P SUBD connector. We have successfully bridged up to 50m between the serial port and the last digit, using standard UTP (twisted pair) cable. Make sure to remove resistor R2 (terminator) from all K8063 units **except** the last unit (unit n in the example above).

Controlling one or more K8063 via a computer:

In order to display information on the K8063, you need to send it a correct data string. The data string consists of 5 bytes :

Byte 1 : chr\$(13)

(letting the K8063 know that data will come in)

Byte 2 : address (0 to 255)

(determines the individual K8063 you want to access. Note: Address '0' accesses all connected K8063)

Byte3 : command

(A # of commands are available, to control the various functions of the K8063, see list of commands)

Byte4 : parameter

(Most commands require a parameter. See list of commands)

Byte5 : checksum

Two-compliment of the sum of the previous 4 bytes

$256 - (\text{Byte1} + \text{Byte2} + \text{Byte3} + \text{Byte4}) \text{ MOD } 256$

Available commands:

<u>Command</u>	<u>Description</u>	<u>Parameter</u>
'E'	E mergency stop	Don't care (anything goes)
'D'	D isplay address on all digits	Don't care
'B'	B yte-command	0..255 (see drawing)
'S'	S trobe command	Don't care
'C'	C hange address	0..255 (new address)
'R'	R eset all displays	Don't care
'F'	F orce address	Don't care
'A'	A send ASCII	32,48..57 (blank, 0..9)
'P'	P decimal point	0 or 255 (OFF / ON)
'I'	I ntensity control	0 or 255 (BRIGHT / DIM)

'E' : Emergency stop. All displays are blanked, regardless of address.
 (Hint : execute the 'Strobe' command to restore all displays)

'D' : Display address all digits. All digits show their address. Addresses between 0 and 9 are displayed as 0 to 9
 Addresses between 10 and 19 are displayed as 0. to 9. (See earlier). Addresses between 20 and 255 are displayed in a binary fashion (see drawing).

'B' : Allows you to turn on individual segments. Parameter = sum of the values of the individual segments (see drawing 7.0) (e.g. 7 = 32+4+8= 44).

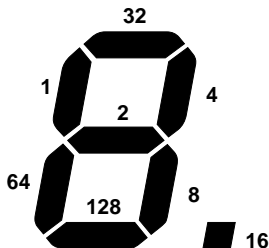

Fig 7.0

'S' : Strobe command. After executing a 'B', 'A' or 'P' -command, the displays are not updated, you need to execute the 'S'-command. By doing this, all displays are updated at the same time.

'C' : Change address. Allows you to change the address of an individual K8063. Put jumper SK7 in place on each K8063 which needs to respond to the 'change address'-command. When the command has been executed, the new address is displayed. Remove the jumper(s).

'R' : In the unlikely event of strange behavior of one or more displays, you can reset all displays at once by executing this command.

'F' : Force all displays to address '1' (return to factory settings).

'A' : Send ASCII to display. An easy way of displaying figures 0 to 9
Simply send their ASCII value. (32ascii blanks the display, 0 = 48ascii, 9 = 57ascii).

'P' : Decimal point control. Parameter 255 turns the decimal point on, parameter 0 turns it off. Decimal point remains on until it has been forced off.

'I' : Brightness control. Parameter 255 set the display to 'dim', parameter 0 sets the display to 'bright'.

Remark : For best results, we recommend to send the command string at least three times a row. When the brightness is set to dim, it is recommended to send the string at least 4 times to make sure all displays are updated.

Furthermore, we recommend a delay of at least 100ms between sending a command and sending the 'Strobe'-command.

Command string examples :

EX1: To reset all displays : Execute the 'R'-command

Data to be sent to serial port :

Chr\$(13) (Init command)
Chr\$(8) (Don't care)
Chr\$(82) "R" = Reset command
Chr\$(1) (Don't care)
Chr\$(152) (Checksum : 2-compliment of the sum of the 4 previous bytes)

EX2: To display a '0' on all units with address '1' : Execute the 'A'-command and supply address '1'.
Next, execute the 'S' (strobe) command.

Data to be sent to serial port :

Chr\$(13) (Init command)
Chr\$(1) (Address 1)
Chr\$(65) "A" = ASCII command
Chr\$(48) (ASCII value of zero = 48)
Chr\$(129) (Checksum : 2-compliment of the sum of the 4 previous bytes)
100ms pause
Chr\$(13) (Init command)
Chr\$(8) (Don't care)
Chr\$(83) "S" = strobe command
Chr\$(1) (Don't care)
Chr\$(151) (Checksum : 2-compliment of the sum of the 4 previous bytes)

EX3: To turn on all segments on all units with address '1' : Execute the 'B'-command and supply address '1'. Next, execute the 'S' (strobe) command.

Data to be sent to serial port :

Chr\$(13) (Init command)
 Chr\$(1) (Address 1)
 Chr\$(66) "B" = Byte command
 Chr\$(255) (255 = sum of segments)
 Chr\$(177) (Checksum : 2-compliment of the sum of the 4 previous bytes)
 100ms pause
 Chr\$(13) (Init command)
 Chr\$(8) (Don't care)
 Chr\$(83) "S" = strobe command
 Chr\$(1) (Don't care)
 Chr\$(151) (Checksum : 2-compliment of the sum of the 4 previous bytes)



Note : Our website www.velleman.be features some example programs written in VB6 which can be used as a guide for writing your own software (source code is supplied).

16. PCB

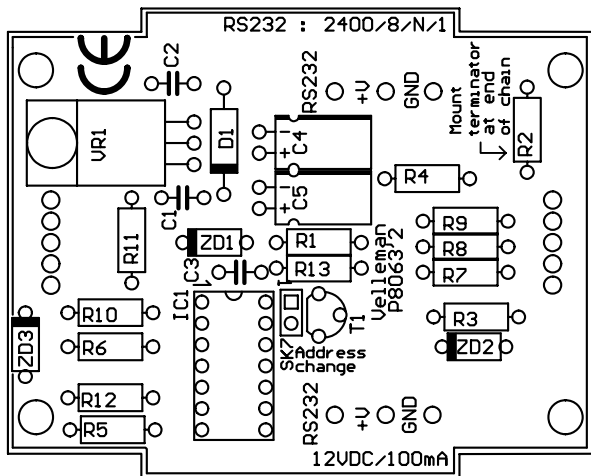



Modifications and typographical errors reserved

© Velleman Components nv.

H8063IP - 2004 - ED1 (rev 4)

