

Total solder points: 29

Difficulty level: *beginner* 1 2 3 4 5 *advanced*

3,5A SUPPRESSED DIMMER

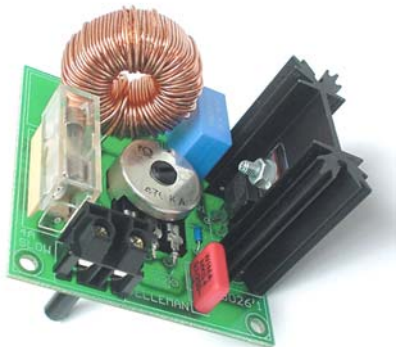

K8026

Dimmer for incandescent
light bulbs and collector motors

Features:

- ☑ Dimmer for incandescent lightbulbs and collector motors.
- ☑ protected against induction voltage peaks.
- ☑ Suppressed according to EN55015.

Specifications:

- AC power : 110-125 or 220-240VAC 50/60Hz.
- Max. load : 3.5A (750W/220V; 375W/110V).
- Dimensions: 60x60x40 mm (2.4"x2.4"x1.6").

1. Assembly (Skipping this can lead to troubles !)

Ok, so we have your attention. These hints will help you to make this project successful. Read them carefully.

1.1 Make sure you have the right tools:

- A good quality soldering iron (25-40W) with a small tip.
- Wipe it often on a wet sponge or cloth, to keep it clean; then apply solder to the tip, to give it a wet look. This is called 'thinning' and will protect the tip, and enables you to make good connections. When solder rolls off the tip, it needs cleaning.
- Thin raisin-core solder. Do not use any flux or grease.
- A diagonal cutter to trim excess wires. To avoid injury when cutting excess leads, hold the lead so they cannot fly towards the eyes.
- Needle nose pliers, for bending leads, or to hold components in place.
- Small blade and Phillips screwdrivers. A basic range is fine.

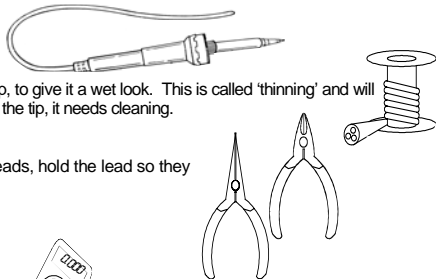

For some projects, a basic multi-meter is required, or might be handy



1.2 Assembly Hints :

- ⇒ Make sure the skill level matches your experience, to avoid disappointments.
- ⇒ Follow the instructions carefully. Read and understand the entire step before you perform each operation.
- ⇒ Perform the assembly in the correct order as stated in this manual
- ⇒ Position all parts on the PCB (Printed Circuit Board) as shown on the drawings.
- ⇒ Values on the circuit diagram are subject to changes.
- ⇒ Values in this assembly guide are correct*
- ⇒ Use the check-boxes to mark your progress.
- ⇒ Please read the included information on safety and customer service

* Typographical inaccuracies excluded. Always look for possible last minute manual updates, indicated as 'NOTE' on a separate leaflet.

1.3 Soldering Hints :

1- Mount the component against the PCB surface and carefully solder the leads

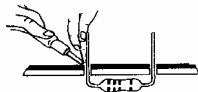

2- Make sure the solder joints are cone-shaped and shiny

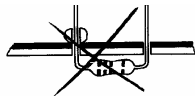
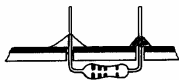

3- Trim excess leads as close as possible to the solder joint

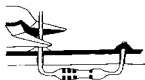

REMOVE THEM FROM THE TAPE ONE AT A TIME !

**AXIAL COMPONENTS ARE TAPED IN THE
CORRECT MOUNTING SEQUENCE !**

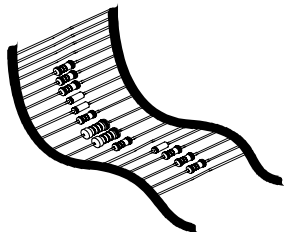

 You will find the colour code for the resistances and the LEDs in the HALG (general manual) and on our website: <http://www.velleman.be/common/service.aspx>

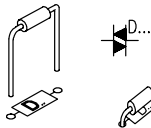
1. Diac.

- D1 : D0200 or eq.

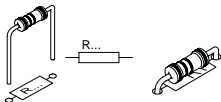
2. Resistor

- R1 : 5K6 (5 - 6 - 2 - B)

FOR 110/125V ONLY :

- R2 : 220K (2 - 2 - 4 - B)

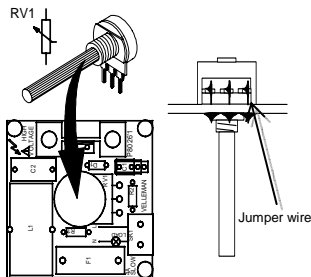
3. Potentiometer

- RV1 : 470K

Use supplied jumper wire to connect as shown.

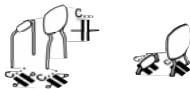
4. Capacitors

- C1 : 100nF (104)

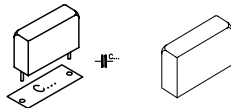

- C2 : 100nF / 250VAC

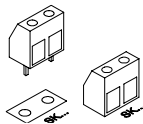
5. Terminal block

- SK1

6. Fuse holder + fuse

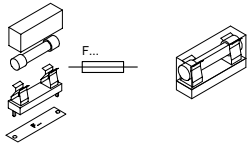

F1 (4A T)

7. Coil

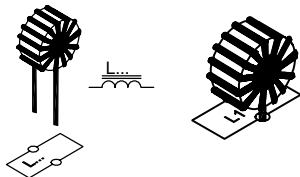

L1 : 1,5mH / 1KHz. - 4A

8. Triac

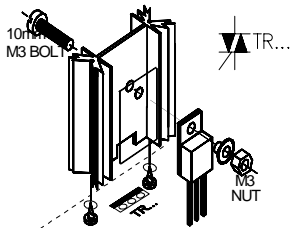

TR1 : TIC225M or eq.

Important : Put an extra layer of solder on all pre-thinned PCB tracks, to improve their current handling capabilities.

9. Hook-up example

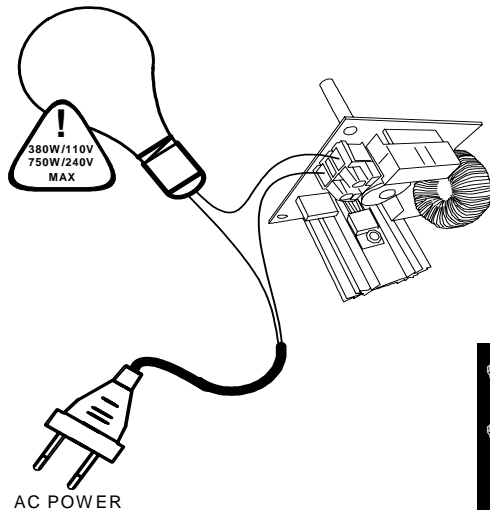

- ⚠ **WARNING : All parts carry lethal voltages!**
- ⚠ **Do not touch while operating. Use an isolated enclosure knob.**

10. Schematic diagram.

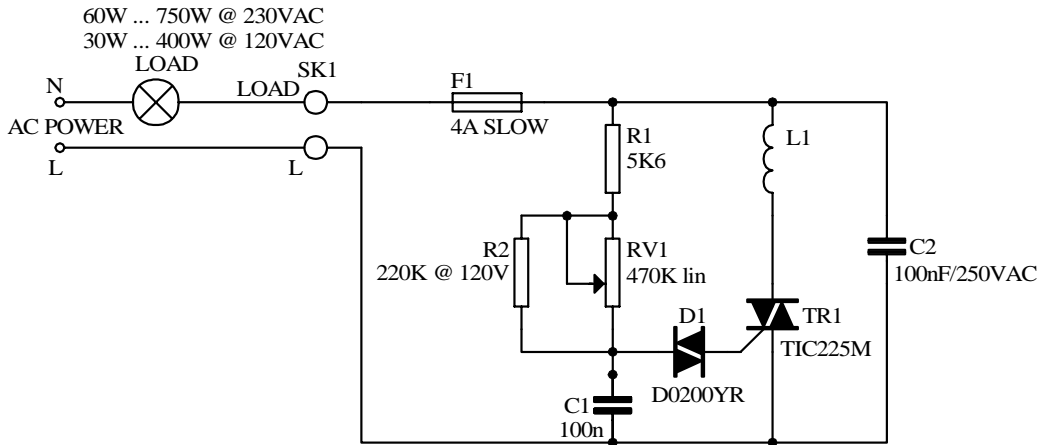

11. PCB

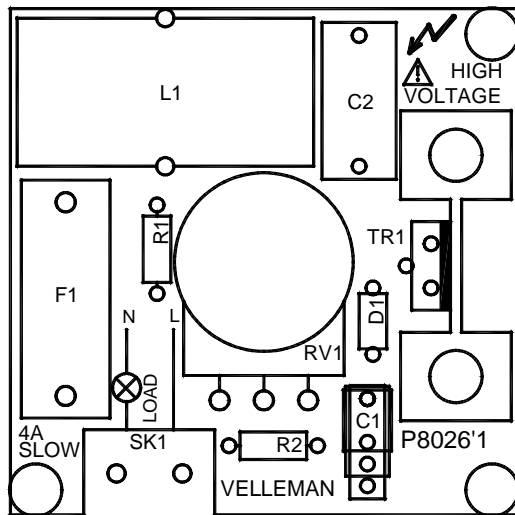



Modifications and typographical errors reserved
© Velleman Components nv.
H8026IP - 2004 - ED1

