

Total solder points: 60

Difficulty level: *beginner* 1 2 3 4 5 *advanced*

MAINS VOLTAGE DETECTOR

K7101

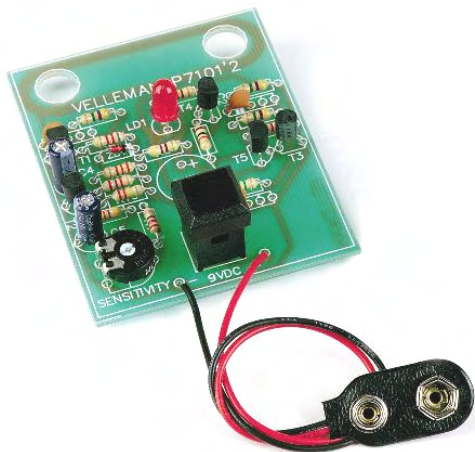

With this device wires can be very easily checked for mains voltage.



VELLEMAN NV
Legen Heirweg 33
9890 Gavere
Belgium Europe
www.velleman.be
www.velleman-kit.com

With this kit one can easily determine whether a wire is live or not. This kit can be used to detect wiring within walls or breaks in cabling. A flashing LED shows whether a current is detected, while the speed at which the LED flashes indicates how close one is to the wiring. For those wanting an audible signal, space is provided on the print for connecting a buzzer type SV4/12. The small PCB has been specially designed to be incorporated into the separately available casing type G407.

TECHNICAL SPECIFICATIONS

- Detection of phase conductor
- LED indicator (buzzer as option)
- Adjustable detection range (10cm max.)
- Range indication
- Supply: 9V battery
- Dimensions: 56x64mm

1. Assembly (Skipping this can lead to troubles !)

Ok, so we have your attention. These hints will help you to make this project successful. Read them carefully.

1.1 Make sure you have the right tools:

- A good quality soldering iron (25-40W) with a small tip.
- Wipe it often on a wet sponge or cloth, to keep it clean; then apply solder to the tip, to give it a wet look. This is called 'thinning' and will protect the tip, and enables you to make good connections. When solder rolls off the tip, it needs cleaning.
- Thin raisin-core solder. Do not use any flux or grease.
- A diagonal cutter to trim excess wires. To avoid injury when cutting excess leads, hold the lead so they cannot fly towards the eyes.
- Needle nose pliers, for bending leads, or to hold components in place.
- Small blade and Phillips screwdrivers. A basic range is fine.

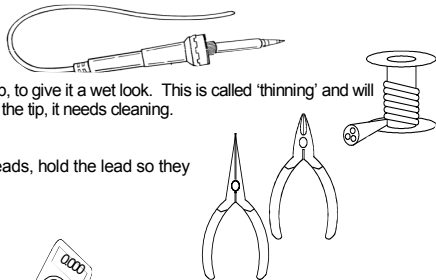

For some projects, a basic multi-meter is required, or might be handy

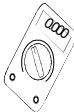

1.2 Assembly Hints :

- ⇒ Make sure the skill level matches your experience, to avoid disappointments.
 - ⇒ Follow the instructions carefully. Read and understand the entire step before you perform each operation.
 - ⇒ Perform the assembly in the correct order as stated in this manual
 - ⇒ Position all parts on the PCB (Printed Circuit Board) as shown on the drawings.
 - ⇒ Values on the circuit diagram are subject to changes.
 - ⇒ Values in this assembly guide are correct*
 - ⇒ Use the check-boxes to mark your progress.
 - ⇒ Please read the included information on safety and customer service
- * Typographical inaccuracies excluded. Always look for possible last minute manual updates, indicated as 'NOTE' on a separate leaflet.

1. Resistors

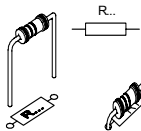

- R1 : 4M7 (4 - 7 - 5 - B)
- R2 : 4M7 (4 - 7 - 5 - B)
- R3 : 8K2 (8 - 2 - 2 - B)
- R4 : 47K (4 - 7 - 3 - B)
- R5 : 470 (4 - 7 - 1 - B)
- R6 : 3K3 (3 - 3 - 2 - B)
- R7 : 330 (3 - 3 - 1 - B)
- R8 : 330 (3 - 3 - 1 - B)
- R9 : 27K (2 - 7 - 3 - B)
- R10 : 330K (3 - 3 - 4 - B)
- R11 : 1M5 (1 - 5 - 5 - B)
- R12 : 4M7 (4 - 7 - 5 - B)
- R13 : 1K (1 - 0 - 2 - B)
- R14 : 10K (1 - 0 - 3 - B)

2. Zenerdiode. Watch the polarity !

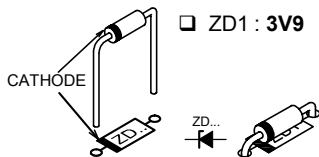

ZD1 : 3V9

3. Capacitors

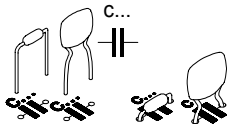

- C1 : 10nF (103)
- C2 : 10nF (103)
- C3 : 10nF (103)

4. Electrolytic Capacitors. Watch the polarity !

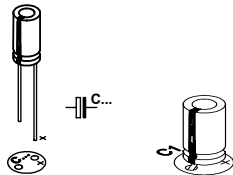

- C4 : 10 μ F
- C5 : 33 μ F

5. Transistors

- T1 : BC547
- T2 : BC547
- T3 : BC547
- T4 : BC547
- T5 : BC557

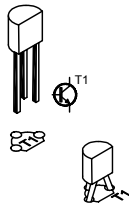

1.3 Soldering Hints :

1- Mount the component against the PCB surface and carefully solder the leads

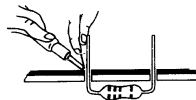

2- Make sure the solder joints are cone-shaped and shiny

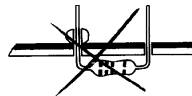
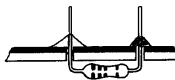

3- Trim excess leads as close as possible to the solder joint

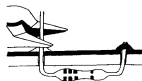

REMOVE THEM FROM THE TAPE ONE AT A TIME !

DO NOT BLINDLY FOLLOW THE ORDER OF THE COMPONENTS ONTO THE TAPE. ALWAYS CHECK THEIR VALUE ON THE PARTS LIST!

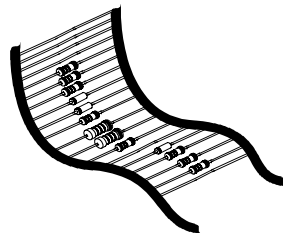

6. LED. Watch the polarity!

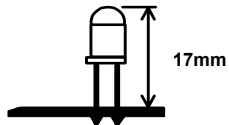

□ LD1 : 5mm red

8. Push button

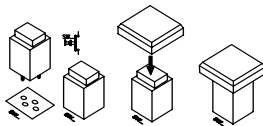

□ SW1 : 1p

7. Trim potentiometer

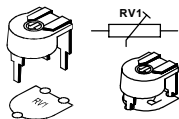

□ RV1 : 470

9. TESTING AND TUNING

- Connect a 9V battery to the holder.
- Stand at a location which is certain to have no mains cabling in the vicinity.
- Turn the RV1 potentiometer completely to the left (counterclockwise).
- Push on the button. Normally the LED should briefly light up.
- Adjust RV1 so that the LED is just about dimmed.

The circuit is now adjusted and in its most sensitive position. If one wishes to decrease the circuit's sensitivity, one must turn the potentiometer back to the left. The small PCB can be incorporated into the casing type B2646. However, one must then provide an opening in the covering for the push-button and the LED (see fig.1.0).

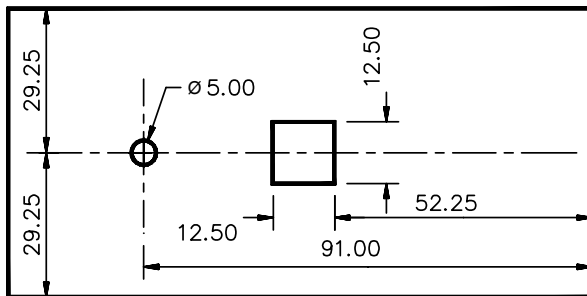
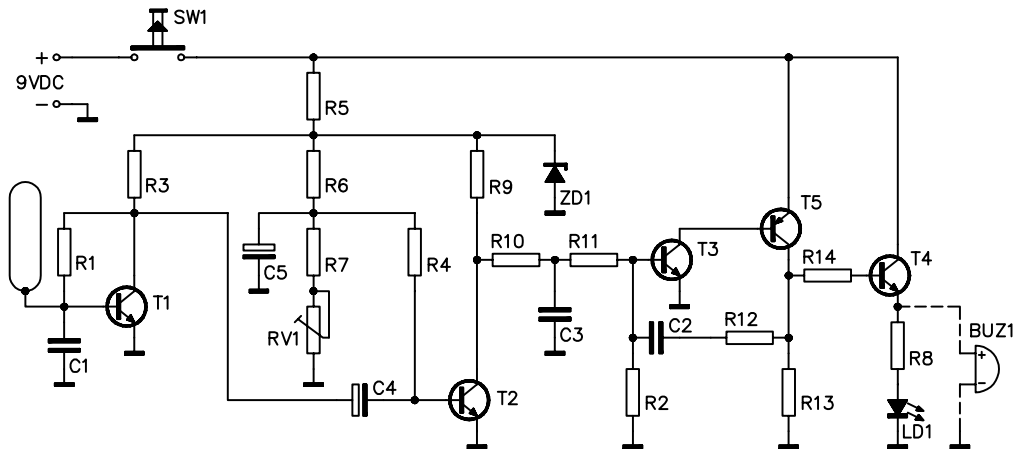

fig. 1.0

Anchor the PCB using two self tapping screws. Finally, cover the push-button with the Cap provided.

10. DIAGRAM



11. PCB

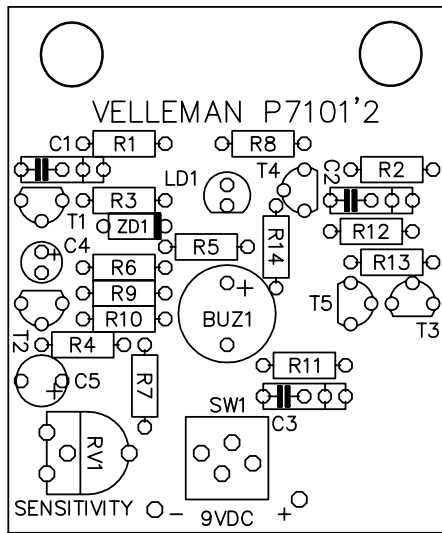

VELBUS
Velleman Home Automation System

VELBUS
Velleman Home Automation System

**All appliances get intelligent, how about your home?
see our website : www.velbus.be**

Modifications and typographical errors reserved
 © Velleman nv.
 H7101IP - 2007 - ED1

VELLEMAN NV
Legen Heirweg 33, 9890 Gavere
Belgium - Europe

