

Sirene

K2604

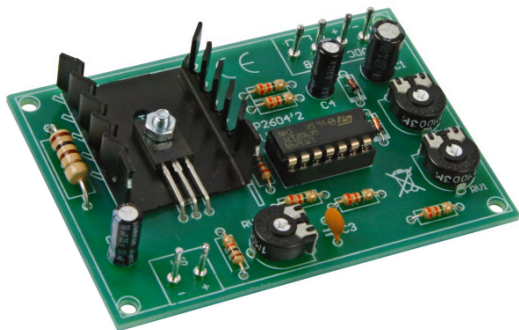

Enter the world of amazing
electronic sounds and noises

Specifications

- power supply: 8 - 14VDC / 1A
- modulation speed: 0.5 - 5s
- frequency: 300 - 6000Hz
- output power: +/- 2W max.
- dimensions: 80 x 55 x 15mm/3.14 x 2.16 x 0.6"

1. Assembly (Skipping this can lead to troubles !)

Ok, so we have your attention. These hints will help you to make this project successful. Read them carefully.

1.1 Make sure you have the right tools:

- A good quality soldering iron (25-40W) with a small tip.
- Wipe it often on a wet sponge or cloth, to keep it clean; then apply solder to the tip, to give it a wet look. This is called 'thinning' and will protect the tip, and enables you to make good connections. When solder rolls off the tip, it needs cleaning.
- Thin raisin-core solder. Do not use any flux or grease.
- A diagonal cutter to trim excess wires. To avoid injury when cutting excess leads, hold the lead so they cannot fly towards the eyes.
- Needle nose pliers, for bending leads, or to hold components in place.
- Small blade and Phillips screwdrivers. A basic range is fine.

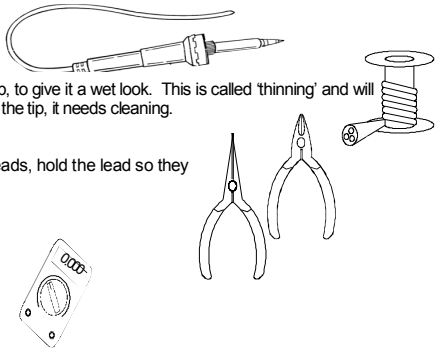

For some projects, a basic multi-meter is required, or might be handy

**1.2 Assembly Hints :**

- ⇒ Make sure the skill level matches your experience, to avoid disappointments.
- ⇒ Follow the instructions carefully. Read and understand the entire step before you perform each operation.
- ⇒ Perform the assembly in the correct order as stated in this manual
- ⇒ Position all parts on the PCB (Printed Circuit Board) as shown on the drawings.
- ⇒ Values on the circuit diagram are subject to changes.
- ⇒ Values in this assembly guide are correct*
- ⇒ Use the check-boxes to mark your progress.
- ⇒ Please read the included information on safety and customer service

* Typographical inaccuracies excluded. Always look for possible last minute manual updates, indicated as 'NOTE' on a separate leaflet.

1.3 Soldering Hints :

1- Mount the component against the PCB surface and carefully solder the leads

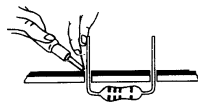

2- Make sure the solder joints are cone-shaped and shiny

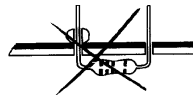
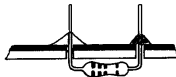

3- Trim excess leads as close as possible to the solder joint

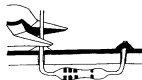

REMOVE THEM FROM THE TAPE ONE AT A TIME !

DO NOT BLINDLY FOLLOW THE ORDER OF THE COMPONENTS ONTO THE TAPE. ALWAYS CHECK THEIR VALUE ON THE PARTS LIST!

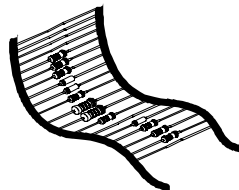

1. Resistors

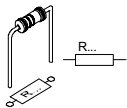

- R1 ... R6 : 3M3 (3-3-5-B)
- R7 : 10K (1-0-3-B)

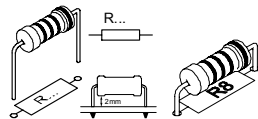

- R8 : 100 (1-0-1-B)

3. IC socket. Watch the position of the notch!

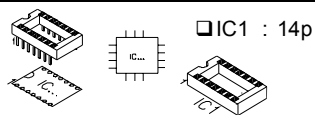

4. Capacitor

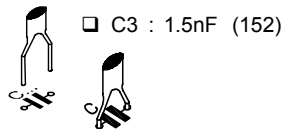

- C3 : 1.5nF (152)

5. Trimmer

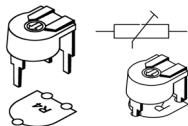

- RV1 ... RV3 : 1M

6. PCB tab

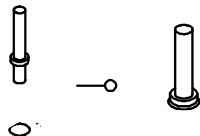

- VDC (2x) "DC power supply"
- PB (2x) "Push button"
- LS(2x) "Loudspeaker"

7. Electrolytic Capacitors. Watch the polarity!

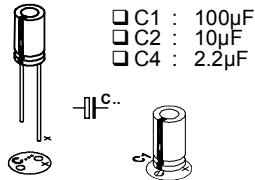

- C1 : 100µF
- C2 : 10µF
- C4 : 2.2µF

2. Diodes. Watch the polarity!

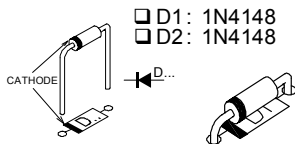

- D1: 1N4148
- D2: 1N4148

8. Transistor

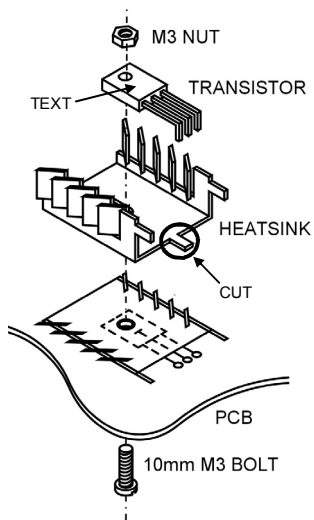

□ T1 : BD681

9. IC. Watch the position of the notch!

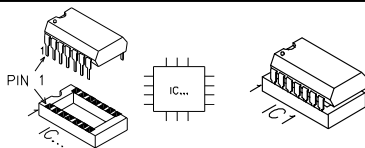

Control

1. Place all 3 trimmers in their mid-position.
2. Connect a push-button or switch to the "PB" contacts.
3. Connect a loudspeaker (4-16ohm) to the points "LS".
4. Connect a power supply (8-14VDC) to the points "VDC", check for the correct polarity!
5. Press the button or switch to start.
6. Trim RV1, RV2 and RV3 to obtain the desired effect. The positive and the negative sweep (modulation) are adjusted respectively with RV1 and RV2. Trimmer RV3 adjust the frequency.



TIP: use a 4ohm/5W resistor for R8 and a loudspeaker of 3-5W to obtain a louder siren.

Schematic diagram

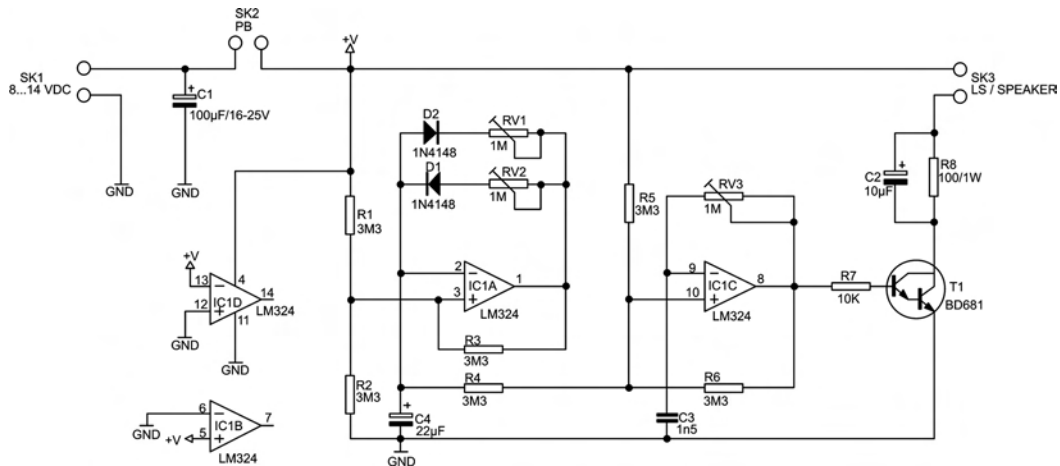

PCB

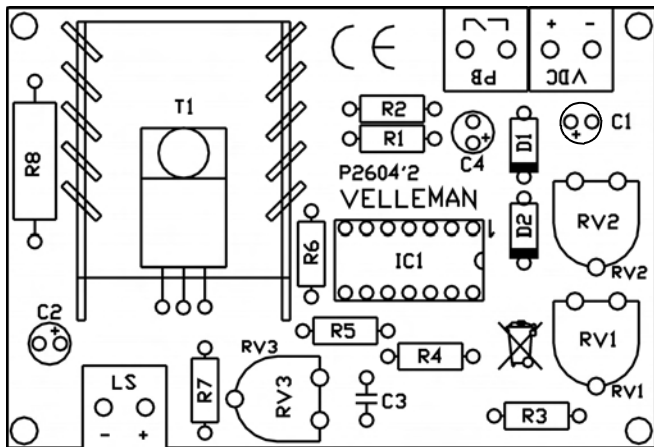

VELBUS
Velleman Home Automation System

VELBUS
Velleman Home Automation System

**All appliances get intelligent, how about your home?
see our website : www.velbus.be**

Modifications and typographical errors reserved
 © Velleman nv.
 H2604IP'1 - 2010

VELLEMAN NV
Legen Heirweg 33, 9890 Gavere
Belgium - Europe

